



Release guide

Release guide

ERDAS IMAGINE 2022 Update 2

Version 16.7.2

6 July 2022

Contents

About this release	4
ERDAS IMAGINE product tiers	4
New platforms	5
Windows 11 status.....	5
Licensing	5
Security vulnerabilities	5
New technology	6
Spatial Modeler.....	6
Option to persist styling for previews	6
Ports supporting IMAGINE.RangeList now have a pop-up dialog	7
Updated Spatial Modeler operators	8
Apply AOI.....	8
Associate Georeference.....	8
Compute Footprint.....	9
Convert to Raster	9
Define Processing Area.....	10
Transform Elevation	10
Get TIFF Options.....	11
Get Warp Options.....	11
Tasseled Cap operator updated for Sentinel-2 L2 data	12
Segment Image Using Deep Learning.....	12
Statistics.....	12
Format Support.....	14
Landsat Collection 2 Analysis Ready Data (ARD)	14
Landsat 9	14
ICEYE in IMAGINE SAR Interferometry	14
GeoTIFF Exporter	14
GeoTIFF NoData Mask	14
GeoTIFF RPC Coefficients.....	14
Capella data	14
Sentinel-1 GRDM	14

Planet SuperDove	14
Create new File Geodatabase and GeoPackage files	15
LAS Format 1.4 Revision 15.....	15
LAS Extended Variable Length Records	15
COSMO-SkyMed Second Gen SCS_B	15
General ERDAS IMAGINE.....	16
Vegetation Indices.....	16
Three-click Rotated Rectangle tool	20
Replacement Sensor Models (RSM) default to using Global Elevation Library	20
Thematic Image Chain	20
Reproject.....	21
EPSG 4087	21
MosaicPro and BigTIFF.....	21
System requirements.....	22
ERDAS IMAGINE	22
ERDAS IMAGINE System requirements notes	23
Issues resolved: ERDAS IMAGINE 2022 Update 2	24
IMAGINE Essentials	24
IMAGINE Advantage	24
IMAGINE Photogrammetry	25
IMAGINE Professional.....	25
Spatial Modeler.....	26
About Hexagon.....	27

About this release

This document describes enhancements in ERDAS IMAGINE 2022 Update 2 (v16.7.2), including IMAGINE Photogrammetry (formerly LPS Core).

ERDAS IMAGINE 2022 Update 2 includes both enhancements and fixes. For information on fixes that were made to ERDAS IMAGINE, see the [Issues resolved](#) section.

This document is only an overview and does not provide all the details about the product's capabilities. See [the product description](#), [the online help](#) and other documents provided with ERDAS IMAGINE for more information.

ERDAS IMAGINE product tiers

ERDAS IMAGINE performs advanced remote sensing analysis and spatial modeling to create added information. You can also visualize results in 2D, 3D, or video and on cartographic-quality map compositions. The core of the ERDAS IMAGINE product suite is scalable to your geospatial data. Optional modules (add-ons) provide specialized functions to enhance productivity.

IMAGINE Essentials is the entry-level image processing product for map creation and simple feature collection tools. IMAGINE Essentials enables serial batch processing.

IMAGINE Advantage enables advanced spectral processing, image registration, mosaicking and image analysis, and change detection capabilities. IMAGINE Advantage allows you to process parallel batches for faster output.

IMAGINE Professional includes a production toolset for spatial modeling, image classification, feature extraction, and advanced spectral, hyperspectral, and radar processing.

IMAGINE Photogrammetry maximizes productivity with state-of-the-art photogrammetric satellite and aerial image processing algorithms.

New platforms

Windows 11 status

ERDAS IMAGINE 2022 Update 2 has been tested using release versions of Windows 11 Enterprise 21H2 (Build 22000.556), and all urgent issues found were addressed. It is therefore expected that ERDAS IMAGINE 2022 Update 2 will work with released versions of Windows 11.

However, Windows 11 is still not considered an officially supported platform for running ERDAS IMAGINE 2022 Update 2. An announcement regarding support will be made at a later date.

Licensing

ERDAS IMAGINE 2022 installers no longer attempt to automatically install geospatial licensing tools as part of the installer. If you wish to use geospatial licensing tools — for example, to set up a floating/concurrent license server — you must download Geospatial Licensing 2022 separately.

We strongly recommend upgrading to the newest version of Geospatial Licensing 2022. If you are unsure of your current version, refer to the Microsoft Windows Add or Remove Programs utility.

You can find the appropriate download in the [Downloads](#) section of the Hexagon website.

Security vulnerabilities

A new section has been added to the Hexagon Community site to track security vulnerabilities and their potential impact on Hexagon products, including ERDAS IMAGINE. Please refer to his link for further information:

[Technical alerts \(hexagon.com\)](#)

New technology

Spatial Modeler

Option to persist styling for previews

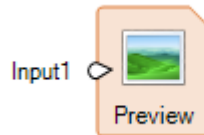

The Preview operator provides an extremely powerful tool for checking the results of your spatial model as you develop it and provides a real-time display of applying the model to different input datasets (and with differing input parameters).

For example, you might be developing a spatial model for pan-sharpening lower-resolution multispectral imagery. Your regular inputs might be BGRN 4-band multispectral and a high-resolution pan image; the model sharpens all four input bands. When you preview the spatial model results, Spatial Modeler will use default parameters (such as Preference settings) to decide which of the four output bands should be displayed in the Preview window. This might normally be a 4,3,2 false-color infrared combination. But what if you really normally want to see a 3,2,1 true-color combination for this model? It's easy enough to change the band combination, and other styling parameters for the Preview window display, on the Multispectral tab. But in previous versions of Spatial Modeler, this styling choice is not persistent, so if you passed the model to another user, the preview would default back to 4,3,2. Similarly, every time you turn off the preview and then turn it back on, it would return to the default styling.

Another example might be running a basic operation such as a Normalized Difference Vegetation Index (NDVI) and previewing the resulting continuous floating point values. By default, this would use the Panchromatic image chain for a greyscale display. But it would be much easier to interpret the results if you switch to the Pseudocolor image chain and apply a Red through Violet color ramp to the NDVI values. It would also be much easier to share this with other users if that styling were retained as part of the spatial model so that the preview always defaulted to a color ramped Pseudocolor style.

For Update 2, two new choices have been added to the Spatial Modeler tab > Execute group > Preview pull-down menu to facilitate the persistence of preview styling (and its removal).

These options are enabled when one or more Preview operators are selected in the Spatial Model being edited. See the screenshot below.

- Persist Styling will persist the Image Chain styling currently being used to populate the selected Preview(s). Thus, if the Preview is turned off and then back on again within the same Spatial Model Editor session the persisted styling will be re-applied to the Preview(s).

Note that if you subsequently change the styling in the Preview it will not be automatically persisted – you must select the Persist Styling option again.

Also note that the persisted styling is only saved to the .gmdx file if the Spatial Model itself is saved.

- Clear Styling will remove the persisted state Image Chain styling for the selected Preview(s). However the styling of the selected Preview(s) will not be immediately affected – select the tab for the current Preview window and click Reset in the Settings group to return the display to the default styling, or change the styling as desired.

Again note that if you Clear Styling, you may wish to save the spatial model so that cleared state is saved.

Persisted styling may not always be appropriate if the input data or other parameters are changed on the spatial model. Consequently an Information flag is always displayed at the lower right corner of any Preview operator which has non-default persisted styling set on it and a message is shown in the Messages pane. This should alert users of the spatial model to the fact that non-default styling is being applied so that it can be cleared (and reset) if the resulting Preview display is misleading.

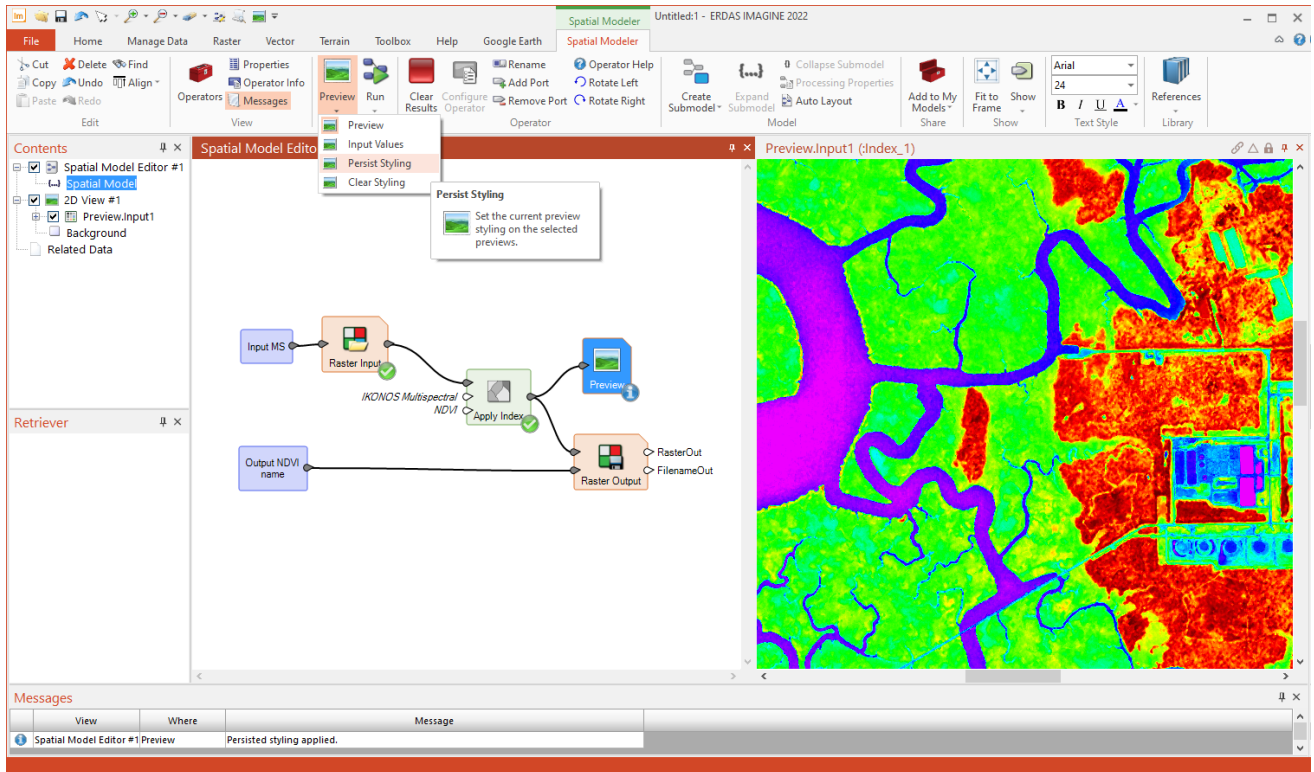

Ports supporting IMAGINE.RangeList now have a pop-up dialog

Not all operator input ports have pop-up dialogs to assist in specifying an input value. For example, Correlation has Ignore and SkipFactor ports.

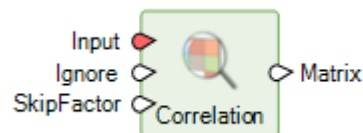

If you double-click SkipFactor, a widget pops up to specify the value. However, you can't double-click Ignore — you have to go to the Properties pane to specify that value (or feed it via another operator). This is because the object types supported by a port may not have a dialog defined for them. In the case of the Ignore port, IMAGINE.Scalar does not have a dialog, whereas the IMAGINE.Int supported by SkipFactor does.

This discrepancy could cause confusion when trying to define the inputs for operators; consequently, there is an ongoing effort to add dialogs for as many object types as possible.

For example, previously, the IMAGINE.RangeList object type supported by operators such as Band Selection did not have a dialog. This has been addressed for Update 2.

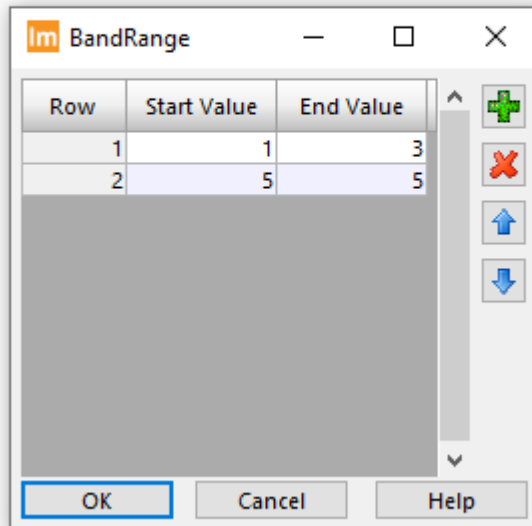

Updated Spatial Modeler operators

Apply AOI

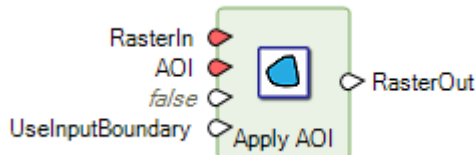

The Apply AOI has had a new input port added called UseInputBoundary. This was added because, depending on the type of data fed to the AOI input port, it could be ambiguous whether the extent of the output Raster should be the extent of the geometries used or the boundary of the data. For example, it is common for an AOI file to have a boundary that extends much further than the extents of the geometries it contains.

The UseInputBoundary port determines whether the output Raster boundary is set to the boundary of the input or to the extent of the input geometry elements.

Associate Georeference



Previously, the Associate Georeference operator with Features input on GeospatialDataIn and a Boundary for Georeferencing port only replaced the CRS ID of the existing Features boundary. Updating the boundary could be achieved by getting the CRS ID from the boundary and applying that to the Georeferencing port.

Now, the operator places the boundary entirely with the value from the Geoereferencing port as a convenient method for supplying a boundary to an existing Features stream.

The operator has also been updated so that GeospatialDataIn can be Point Cloud data (in addition to the Raster and Features previously supported).

Compute Footprint

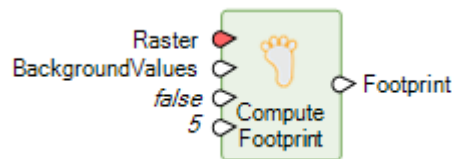

This operator generates the not-necessarily-rectangular footprint for raster data. The output Footprint is the outline polygon that defines the extent/boundary of the input Raster's valid (non-NoData, as determined by mask or supplied background values) area.

In previous versions, the CropAreaPercent port was used only if the FourCorners port was set to True. This limitation has been removed for Update 2 such that irregular footprints can now also be trimmed by the specified percent. Cropping is a useful option to remove (or avoid) edge artifacts, which may occur in some imagery.

Convert to Raster

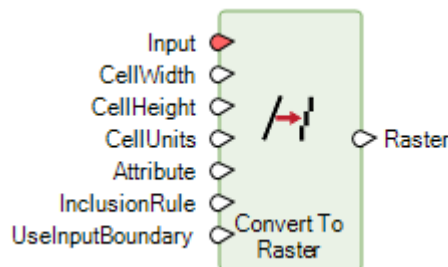

A UseInputBoundary port has been added to control the extent of the Raster that is created. This was added because, depending on the type of data fed to the Input port, it could be ambiguous whether the extent of the output Raster should be the extent of the geometries used or the boundary of the data. For example, it is common for an AOI file to have a boundary that extends much further than the extents of the geometries it contains.

The UseInputBoundary port determines whether the output Raster boundary is set to the boundary of the input or to the extent of the input geometry elements.

Define Processing Area

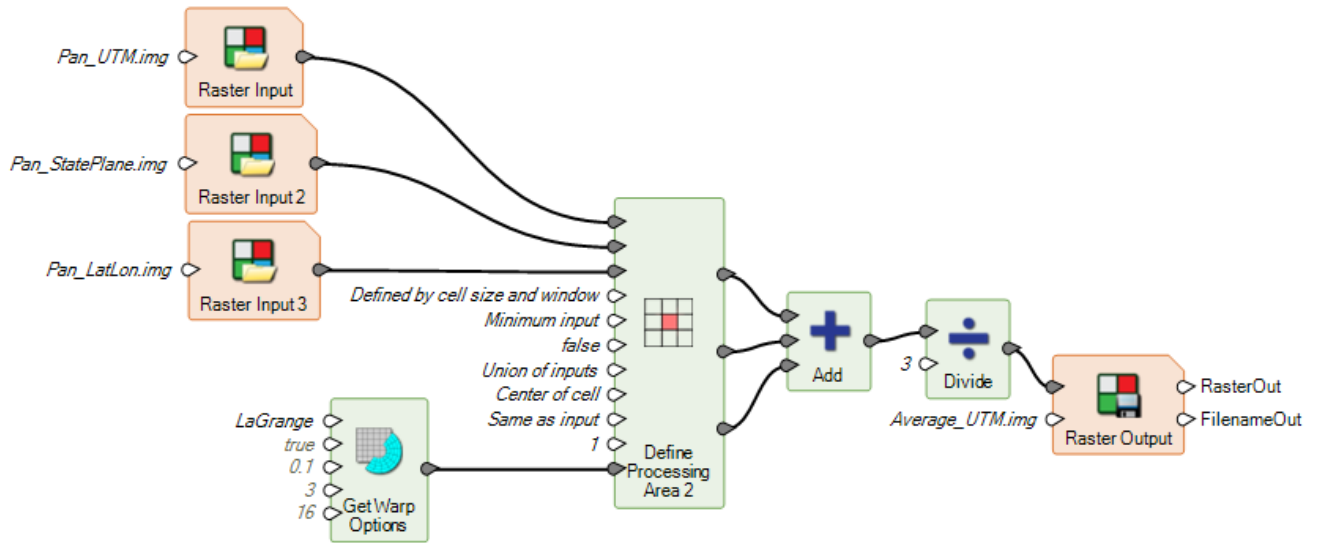

The Define Processing Area operator is primarily used to specify what happens when two or more Raster streams are combined in a downstream process. For example, if two raster streams have differing boundaries, do you want the combined stream to be the default intersection of the two, or the union, or some user-specified extent?

Sometimes the rules could require complex operations to occur on the inputs. For example, if two Raster inputs had differing Projected Coordinate Systems (PCS), the combined raster stream could be referenced to only one PCS, and a choice would have to be made as to what would be used. In this circumstance, at least one input dataset would need to be reprojected on the fly to the selected PCS. In prior releases, for this to work correctly, the designer of the spatial model would need to add Warp operators prior to the Define Processing Area operator to ensure that the input Raster stream was being reprojected or resampled on the fly in the desired fashion.

To simplify this and to make it more evident what is required to build a properly functioning spatial model, the functionality of the Warp operator has been embedded into the Define Processing Area operator and its optional parameters exposed via a WarpOptions port. This port can be used to directly specify the most common requirement, which is a resampling method (e.g., Cubic Convolution instead of the default Nearest Neighbor), or all the same options provided by the Warp operator can be controlled through the use of the new Get Warp Options operator.

Transform Elevation



Transforms the height (z) values of a raster elevation band from one vertical coordinate system to another.

This operator replaces the Elevation Transform operator, which has been deprecated.

The deprecated operator maintained the bit-depth of the input ElevationIn on the ElevationOut, potentially resulting in loss of height accuracy if not worked around. This new version instead always outputs at least Float 32-bit data to maintain accuracy.

It should also be noted that the new operator lacks an ElevationBand port. Instead it expects the input to be a single-band raster, so a Band Selection operator may need to be used prior to Transform Elevation to select the appropriate elevation band.

Get TIFF Options

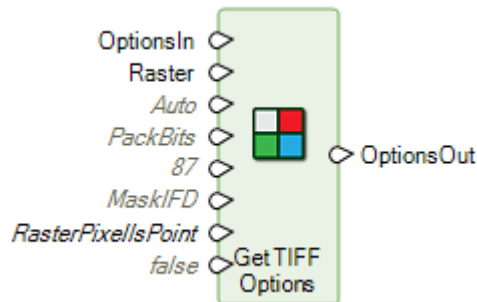

The Get TIFF Options operator has had two new ports added to it to help control the formatting of TIFF files output by a connected Raster Output operator.

The GTRasterType port determines whether the coordinates of an output GeoTIFF are aligned to center of cell or corner of cell. There is an Auto setting (which is the default behavior) whereby if a VerticalCRS is present, RasterPixellsPoint is used; otherwise RasterPixellsArea is used. Alternatively, the port can be set explicitly to RasterPixellsPoint or RasterPixellsArea. Refer to the GeoTIFF specification for more information.

The MaskPersistence port controls how to persist the NoData mask accumulated by the spatial model process. Acceptable values are:

- None: The NoData mask will not be persisted. A NoData value will be used when necessary or specified explicitly on the Raster Output operator.
- Alpha: The NoData mask will be persisted as an unassociated alpha channel. This option is provided for backward compatibility only — it is strongly recommended to use MaskIFD instead.
- MaskIFD: The NoData mask will be persisted in a separate mask Image File Directory (IFD) when necessary. This is the preferred mask persistence for TIFF because it is space-efficient.

Get Warp Options

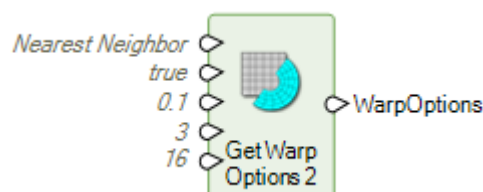

This operator, new for Update 2, has been added in support of the new capabilities added to the Define Processing Area operator (see above). It provides the ability to define options similar to those previously available on the Warp operator.

Tasseled Cap operator updated for Sentinel-2 L2 data

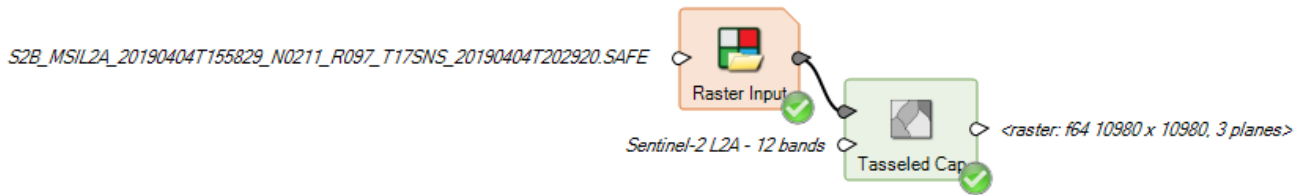

Level 2 Sentinel-2 data has been atmospherically corrected to surface reflectance, so the Cirrus band (Band 10, the 11th layer) is not included. This cuts the dataset down to just 12 bands, which means it did not work with the previous Tasseled Cap operator.

The operator has been updated to support 12-band L2 Sentinel-2 as an input.

Segment Image Using Deep Learning

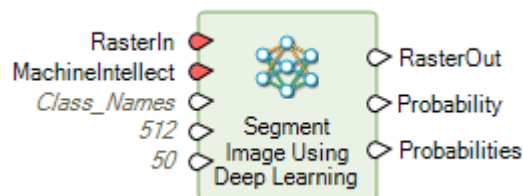

Previously, Segment Image Using Deep Learning had a Probability port that only output a single band raster representing the probability per pixel of that pixel being the class in Raster Out.

However, for these probabilities to be truly useful, we needed a Probabilities port, which outputs an n band raster where each band represents the probability of the pixel being that class.

The values are double precision floating point numbers where 0.0 represents the lowest certainty the pixel was correctly classified for the given class (band) and 1.0 represents the highest certainty. The band names are the name of the class whose probability is indicated.

Statistics

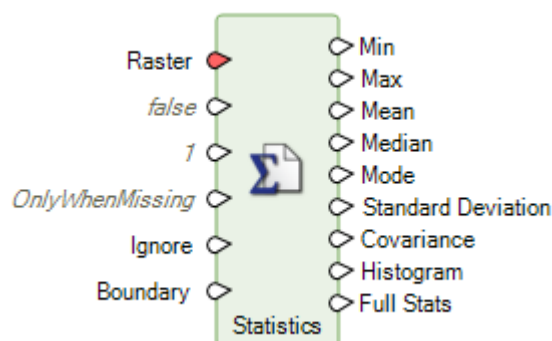

The ForceRecompute port has been modified to accommodate additional circumstances under which it may or may not be desirable to retain an existing bin function (if the input data is Raster).

Option	Behavior
OnlyWhenMissing	Generate statistics only if the input raster dataset does not have existing statistics.
WithNewBinFunctionPreferred	Force new statistics to be generated. Use the existing bin function only if there are attributes besides Histogram in the existing attribute table and the bin function is not Direct.
WithNewBinFunctionRequired	Force new statistics to be generated with a new bin function when the input raster dataset has existing statistics or bin function (attribute table).
WithExistingBinFunction	Force new statistics to be generated. Always use the existing bin function if the input raster dataset has an attribute table. Note that this may not be appropriate if the range of the bin function is different from the actual range of the values in the input raster dataset.

Format Support

Landsat Collection 2 Analysis Ready Data (ARD)

In early 2022, USGS began providing Analysis Ready Data (ARD) versions of Collection 2 Landsat imagery for download via EarthExplorer. The “Landsat 4, 5, 7, 8, or 9 from USGS” Importer has been updated to handle these files and provide a convenient way to form multispectral image stacks from the constituent per-band GeoTIFF files.

Landsat 9

Imagery from Landsat 9 also became available publicly in early 2022. It has been confirmed that the “Landsat 4, 5, 7, 8, or 9 from USGS” Importer works with Collection 2 L1, L2, and ARD data variants.

ICEYE in IMAGINE SAR Interferometry

ICEYE interferometric pair data is now supported in the IMAGINE SAR Interferometry product for deriving information such as DEMs.

GeoTIFF Exporter

The GeoTIFF Exporter has been re-written to use Spatial Modeler, which means it can make use of several of the new capabilities it provides, including those mentioned in the Spatial Modeler sections above.

The exporter’s dialog has also been simplified so that choice of which bands to export is now a range list that automatically adjusts the other options that might be available (such as compression types) based on the number of bands being exported. This also impacts the PhotometricInterpretation tag written to the output TIFF, which may affect how other software packages interpret the TIFF image.

GeoTIFF NoData Mask

The TIFF specification supports a separate IFD (image) that is just the mask of another image. This Mask IFD can be used to represent NoData locations in a TIFF and does so in a much more efficient (disk-space saving) manner than the older Alpha channel specification. Both reading and writing of a Mask IFD is now supported in ERDAS IMAGINE and is the default behavior for storing NoData locations when creating new TIFFs.

GeoTIFF RPC Coefficients

The RPCCoefficient TIFF tag is now supported for both reading and writing. Consequently, TIFFs containing this tag (such as ICEYE GRD imagery) will be automatically associated with the RPC geometry model for spatially locating the data.

Capella data

Previously, bulk downloaded Capella data could have headers populated with incorrect paths to the locations of the files containing the pixel data. ERDAS IMAGINE’s Capella direct-read support has been made more robust to tolerate these issues.

Sentinel-1 GRDM

Support for the GRDM variant of Sentinel-1 data has been added.

Planet SuperDove

SuperDove is a new set of satellites in Planet’s constellation of PlanetScope and RapidEye satellites and can have up to 8 spectral bands.

Create new File Geodatabase and GeoPackage files

New single-layer File Geodatabase and GeoPackage files can now be created in the 2D View, rather than just having the ability to edit existing files.

LAS Format 1.4 Revision 15

Support has been added for LAS format v.1.4 revision 15 which supports additional standard classes. In revision 15, classes 19 – 22 have been standardized to represent Overhead Structures, Ignored ground, Snow and temporal exclusion.

LAS Extended Variable Length Records

LAS Format 1.4 files may store their Coordinate Reference System (CRS) definitions in an Extended Variable Length Record (EVLN). Previously, ERDAS IMAGINE's LAS support did not read or write EVLNs. This lack of support meant that some customer data appeared to have no CRS even when one had been defined. This has been rectified.

COSMO-SkyMed Second Gen SCS_B

COSMO-SkyMed Second Gen SCS_B data was being incorrectly displayed. It is now being correctly unpacked to Magnitude and Phase.

General ERDAS IMAGINE

Vegetation Indices

The spatial models that underly the Indices dialog have been overhauled to use modern versions of operators, such as the Math operators. In addition, the update addresses some issues that were found and names the output bands less confusingly, and two new vegetation indices were added:

Leaf Area Index (LAI)

The Leaf Area Index (LAI) estimates foliage cover using the following formula, derived from Boegh, et al (2002):

$$LAI = (3.618 * EVI - 0.118)$$

Where EVI is the Enhanced Vegetation Index value.

Before calculating a LAI image, you should convert the input imagery to Reflectance (at least top of atmosphere, but preferably surface reflectance) and mask out any bright features that might saturate the LAI, such as clouds and human-made structures.

The Enhanced Vegetation Index was originally developed by Huete, A., et al (2002) for use with MODIS data as an improvement over NDVI by optimizing the vegetation signal in areas of high leaf area index (LAI). It uses the blue reflectance region to correct for soil background signals and to reduce atmospheric influences, including aerosol scattering.

$$EVI = 2.5 * \frac{(NIR - Red)}{(NIR + 6 * Red - 7.5 * Blue + 1)}$$

Landsat 8 False Color IR display (5,4,3):



Leaf Area Index of the same image:

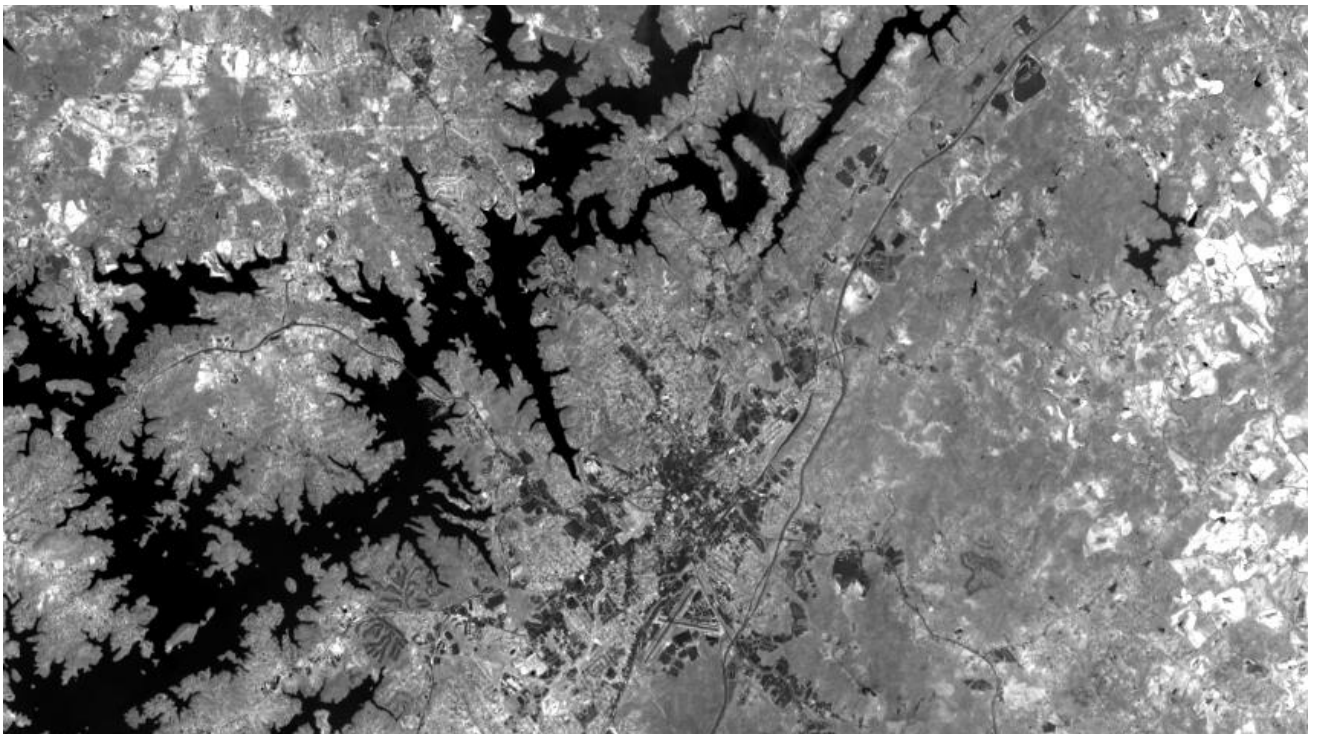

Green Leaf Index (GLI)

The Green Leaf Index (GLI) was designed for use with digital cameras capturing only true-color bands (RGB), scaled 0 to 255. As such, it is useful as a vegetation index that can be applied in the absence of NIR information.

$$GLI = \frac{(Green - Red) + (Green - Blue)}{(2 * Green) + Red + Blue}$$

Note that the lack of NIR information means that the index will detect all materials that are green, not just vegetation. So, for example, a green car or a green roof, will have a high GLI value.

True-color RGB aerial photo:



Green Leaf Index of the same image:



Three-click Rotated Rectangle tool

This new vector editing tool (currently available for annotation and AOI layer types) minimizes the number of clicks needed to draw a rotated rectangle, such as that needed to capture a rectangular building segment from a satellite image or aerial photo.

Click two vertices to define one side of the rectangle (usually the longest edge to maximize precision). These two points determine the angle at which the rectangle will be drawn. Move the cursor to the opposing edge and a rectangle will be drawn in real time to assist in placing the edges accurately. Click the mouse when you are ready to accept the rectangle.



Replacement Sensor Models (RSM) default to using Global Elevation Library

Previously, RSM models would default to using a constant elevation of 0m, which could result in inaccurate positioning if not manually adjusted. With this release, use of RSM models will now default to using the Global Elevation Library (but can still be overridden with alternative elevation sources).

Thematic Image Chain

The Thematic Image Chain has been made more robust in its ability to deal with editing the source raster file, including changing class colors and other attributes, as well as providing support for pixel value editing.

If a thematic raster image is opened using the Thematic Image Chain (or the current Image Chain is changed to Thematic) for a dataset that lacks an existing color table, one will be automatically added and populated with a default pseudo-random set of colors. This set of colors (the Random color ramp available on the Color Table menu) contains 256 colors, so if the dataset it is being automatically applied to contains more than 256

values (or bins), the same set of colors will be repeated to cover all values. This default color styling can be easily replaced using standard tools such as the Colors menu on the Table tab.

Reproject

The Reproject dialog (Raster tab > Geometry group > Reproject) has been reimplemented to replace the previous executable program with a spatial model. This brings several benefits, including a significant improvement in performance and a more consistent handling of NoData.

EPSG 4087

Support has been added for EPSG 4087 (World Equidistant Cylindrical), based on the Equidistant Cylindrical Ellipsoidal projection.

MosaicPro and BigTIFF

The MosaicPro tool will now successfully output directly to the BigTIFF format for data larger than 4 GB in size.

System requirements

ERDAS IMAGINE

Computer/processor	64-bit: Intel 64 (EM64T), AMD 64, or equivalent (four or more logical processors are strongly recommended)
Memory (RAM)	16 GB or more strongly recommended
Disk space	<ul style="list-style-type: none"> 9.5 GB for software 7 GB for optional example data Data storage requirements vary by mapping project¹ SSD drives strongly recommended for both software and data
Operating systems ^{2, 3, 4}	<ul style="list-style-type: none"> Windows 10 Pro (64-bit, version 1607 or higher) Windows 10 Enterprise (64-bit, version 1607 or higher) Windows Server 2019 (64-bit) Windows Server 2022 (64-bit) Windows 11 Enterprise (64-bit) (viable, not currently considered supported)
Software	<ul style="list-style-type: none"> OpenGL 2.1 or higher (this typically comes with supported graphics cards⁵) Java Runtime 1.7.0.80 or higher — IMAGINE Objective requires JRE and can utilize any installed and configured JRE of version 1.7.0.80 or higher; Microsoft Visual C++ 2010 x64 Redistributable is also required Python 3.7.x (Python is optionally usable with Spatial Modeler) Microsoft DirectX[®] 9c or higher .NET Framework 4.7.2 or higher OpenCL 1.2 with a device that supports double precision (cl_khr_fp64) if wanting to GPU accelerate NNDiffuse and other operators (functions should fall back to the CPU if a suitable GPU is not present) An NVIDIA card with CUDA Compute level of 3.5 or greater is recommended for use with Deep Learning and 5.0 or greater for other Spatial Modeler operators (functions should fall back to the CPU if a suitable GPU is not present)
Recommended graphics cards for stereo display ⁶	<ul style="list-style-type: none"> NVIDIA[®] Quadro[®] P6000, P5000, P4000, P2000 NVIDIA[®] Quadro[®] M6000, M5000, M4000, M2000 NVIDIA[®] Quadro[®] K5200, K5000, K4200, K4000, K2200, K600, K420 NVIDIA Quadro RTX 4000 NVIDIA Quadro RTX A4500, RTX A5000
Recommended stereo display monitors	<ul style="list-style-type: none"> 120 Hz (or above) LCD Monitors with NVIDIA 3D Vision™ Kit 3D PluraView system from Schneider Digital⁷ Vision Engineering CONTOUR 3D stereoscopic GIS display
Recommended stereo glasses and emitter kits	<ul style="list-style-type: none"> NVIDIA 3D Vision™ Kit 3DTV Universal Emitter
Peripherals	<p>All software installations:</p> <ul style="list-style-type: none"> One Windows-compatible mouse with scroll wheel or equivalent input device Printing requires Windows-supported hardcopy devices⁸ <p>Software security (Hexagon Geospatial Licensing 2022) requires one of the following:</p> <ul style="list-style-type: none"> Ethernet card One USB port for hardware key <p>Advanced data collection requires one of the following hand controllers:⁹</p>

	<ul style="list-style-type: none"> • TopoMouse™ or TopoMouse USB™ • Immersion 3D Mouse • MOUSE-TRAK • Stealth 3D (Immersion), S3D-E type, Serial Port • Stealth Z, S2-Z model, USB version • Stealth V, S3-V type (add as a serial device) • 3Dconnexion SpaceMouse Pro¹⁰ • 3Dconnexion SpaceExplorer mouse¹⁰ • Z/I Mouse
ArcGIS and GeoMedia interoperability	<ul style="list-style-type: none"> • ERDAS IMAGINE can be safely installed on a computer that has GeoMedia 2020 or GeoMedia 2022 installed; however, for greatest compatibility, it is highly recommended to install matching versions (including updates) • ERDAS IMAGINE 2022 requires GeoMedia 2022 for live linking (order of installation does not matter) • ERDAS IMAGINE can interact with File Geodatabases • ERDAS IMAGINE can be safely installed on a computer that has ArcGIS® versions 10.6 through 10.8.2 (but ArcGIS installation is not required for File Geodatabase access)
Database engines	<ul style="list-style-type: none"> • PostgreSQL 13.2 with PostGIS 3.1.1: PostGIS can be used to store GeoMedia Features (.fpf) • Oracle Server 19c (12.2.0.3) 64-bit: Oracle Server 19c can be used to store Oracle GeoRaster (.ogr) (requires Oracle Spatial), SDE Raster (.sdi) (requires ArcGIS for Server) and Oracle Spatial Features (.ogv) (requires Oracle Spatial), as well as GeoMedia Features (.ofp) • Microsoft SQL Server 2019 64-bit: Microsoft SQL Server 2019 can be used to store GeoMedia Features (.sfp)

ERDAS IMAGINE System requirements notes

¹ Disk I/O is usually the slowest task in geospatial data processing. Faster hard disks improve productivity. Reading data from one disk, writing temporary data to a second disk, and writing data to a third disk improves performance. Disk arrays improve productivity, but some RAID options slow performance. Network disk drives are subject to network limitations.

² Server operating systems are not supported for IMAGINE Photogrammetry, ORIMA, or ERDAS ER Mapper.

³ The 3D stereo viewing and peripheral requirements of IMAGINE Photogrammetry limit its operating system options.

⁴ Includes ERDAS ER Mapper support.

⁵ Windows provides a generic OpenGL driver for all supported graphics cards; however, an OpenGL-optimized graphics card and driver are recommended for these applications.

⁶ Graphics cards certified with previous versions of IMAGINE Photogrammetry and ORIMA may also be compatible but are not certified in the current version. Drivers must not be newer than R418. NVidia dropped 3D Vision support for drivers released after R418 U4 (425.31), which was released on April 11, 2019.

⁷ Stereo monitors certified with previous versions of IMAGINE Photogrammetry and ORIMA may also be compatible but are not certified in the current version.

⁸ HP-RTL drivers are recommended. Windows 64-bit print servers require 64-bit print drivers.

⁹ Stealth S-Mouse (S2-S model) and MOUSE-TRAK are the only supported hand controllers in Stereo Analyst for ERDAS IMAGINE.

¹⁰ 3Dconnexion mice are supported in IMAGINE Photogrammetry.

Issues resolved: ERDAS IMAGINE 2022 Update 2

IMAGINE Essentials

Support Ticket	Summary
00027339	<p>Vector reprojection error</p> <p>A customer reported that ERDAS IMAGINE could not reproject shapefiles to a custom Coordinate Reference System (CRS). The customer added the custom CRS in ERDAS IMAGINE and then tried reprojecting the shapefile. However the customer could reproject raster files to the same custom CRS.</p> <p>The specific custom CRS can now be used when reprojecting shapefiles.</p>
00062848	<p>ERDAS IMAGINE now correctly recognizes the EPSG 6428 Coordinate Reference System (CRS) stored in a LAS file using EVLR and Compound CRS</p>
00023426	<p>An issue has been corrected whereby previously Snail Trail files could not be successfully merged together into a single file. Home tab > Roam group > Snail Trail menu > Merge Snail Trails</p>
00032042	<p>ECW formatted image files can have their NoData Mask defined as being black or white. Previously when displaying an ECW with NoData defined as white using the Image Chain and turning off Pixel Transparency (so that normally transparent NoData locations should be rendered using their opaque color instead) the NoData locations would always be rendered as opaque black. With Update 2 the NoData locations should maintain their color definition.</p>

IMAGINE Advantage

Support Ticket	Summary
00023024	<p>When using the Terrain Prep Tool to create a classified LAS file from a raster DEM, the output point cloud data did not have any projection information. This has been corrected so that the output LAS file maintains the Projected Coordinate System from the input.</p>
00022809	<p>Images selected in the MosaicPro viewer were not highlighted in the image list CellArray.</p>
00022801	<p>When measuring GCPs in the geometric correction tool if you clicked "Toggle Fully Automatic GCP Editing Mode" the reference GCP coordinates would change. But if you just used the "Create GCP" icon to measure GCPs then reference coordinates would not be altered.</p> <p>The software has been modified to not auto-update existing defined input or reference coordinates.</p>
00030527	<p>Change Detection using Discriminant Function no longer crashes with sigma clipping enabled</p>
00023180	<p>If specifying the output file format in MosaicPro to be BigTIFF, it would show the following error:</p> <p>"Error:File will exceed the TIFF limit of 4GB.Please save to a different format"</p> <p>MosaicPro will now successfully produce the output mosaic in BigTIFF format when requested.</p>
00050267	<p>MosaicPro and ortho-resampling tools were producing a blank (empty) RRD pyramid structure when used on a very large image which consisted of a majority of background pixels (which were not defined as NoData) and just a thin diagonal strip of actual imagery running from approximately top right of the file to bottom left. The pyramid generation process when using SIPS Downsampling has been updated to try to avoid this situation with similar data in the future.</p>
00064193	<p>Displaying the results of the Ridge / Valley tool as Image Chain would cause ERDAS IMAGINE to crash. This problem no longer appears to occur.</p>

00023343	MosaicPro was failing when mosaicking more than 3000 images as input and ECW as the output format. This is no longer the case.
00063439	COSMO-SkyMed Second Gen SCS_B data was being incorrectly displayed. It is now being correctly unpacked to Magnitude and Phase.
00054483	The Capella SLC reader has been made more tolerant of formatting inconsistencies.
00072513	Discriminant Function change detection was failing to delete some temporary files it created. This has been corrected. A related issue whereby if the two dates of imagery had differing Coordinate Reference Systems the process would fail remains – the two input images must have the same Coordinate Reference System.

IMAGINE Photogrammetry

Support Ticket	Summary
00022937	After requesting to save a feature class edit, Stereo Analyst for ERDAS IMAGINE (SAFI) did not honor the "Don't Ask This Again" checkbox. If another save is requested, the confirm save dialogue still opened with the "Don't Ask This Again" checkbox unchecked. The software has been updated so that this dialogue does not reopen after every feature edit save request.
00046114	The IMAGINE DSM Extractor was failing to extract a digital surface model from some stereo WorldView 3 imagery. This has been corrected.
00027274	The Automated Point Matching (APM) process was failing (after processing for some time) in ORIMA when processing blocks with more than 100 TIFF images. This has been corrected.
00065305	Using the contrast adjustment tools in the Classic Point Measurement tool was not behaving as expected.
00022912	ORIMA Viewplex settings were not being persisted between user sessions. This concerned, for example, the settings of the cursor (size, color, etc.) as well as the general settings of the ViewPlex (e.g. Fixed Cursor, DRA settings, etc.). Changes of the settings were being saved to the IMAGINE ORIMA Preferences but they were apparently not applied when loading an ORIMA project. They are now applied.
00022791	Photogrammetric block projects using non-WGS84 vertical datum were being problematic. This has been addressed in Update 2, but any existing block file using non-WGS84 vertical datum and triangulated with GCPs should be re-triangulated to have better accuracy. All block files using WGS84 vertical datum are not affected.

IMAGINE Professional

Support Ticket	Summary
00023160	The Objective 'Raster Pixel Processor' Training source File Chooser listed file types outside of the 'Files of Type' menu selection. The file chooser menu selection should pick either AOI or Shapefile file types. When the file chooser initially opened, it was listing <u>all</u> file types from the folder picked in the File Chooser. It will now list just the type selected.
00050949	Subpixel Material of Interest (MOI) Classification runs successfully using two different single signature files. But if you combined the two single signatures files into a combined signature file using the Subpixel Signature Combiner then MOI Classification would fail when using the combined signature file. This has been corrected.

00023297	When using some Floating point, single band panchromatic input imagery Image Segmentation was advancing to 92% then completing without error but producing no output image. The algorithm has been updated to handle single-band floating point imagery with a very narrow dynamic range.
----------	---

Spatial Modeler

Support Ticket	Summary
00071479	<p>Previously, Error windows would pop up when using the Run In Background option to execute a spatial model that uses the Catch Error operator. If the model was executed with the Run button instead of Run in Background the error windows would not display.</p> <p>This has been corrected so that Run In Background does not produce pop-up message windows.</p>
00023550, 00035388	<p>According to the documentation the Buffer Zones Operator should accept IMAGINE.String and IMAGINE.Double input for the Distance input port. This was reported to work for all cases except two.</p> <p>When using a Double input in combination with the DistanceUnit values 'Meters' or 'Native Type' the output of the Buffer Zones operator fails giving the error: Invalid value for the property 'InputDistance'.</p> <p>This has been corrected.</p>
00053221	Raster Statistics Per Feature failed to work with linear geometry in ERDAS IMAGINE 2022 Update 1 (but had worked in prior releases). This has been corrected.
00023079	The Create Random Points operator was taking too long to process data with big NoData gaps. This has been sped up.
00023147	An issue was also reported with Create Random Points operator taking too long when generating large numbers of points. This has also been corrected.
00034220	Two problems were reported with the Add Attributes by Location operator. The first was due to the software not handling an In64 field type resulting in only 0s being added. The second was that the software sometimes had difficulty intersecting points with highly complex / irregular polygonal geometries. Both issues have been corrected.
00023162	An Encrypted Spatial Model using the Filter By Attributes operator would always use the original input values saved with the model rather than user-defined values fed in a run time. The software has been updated to address this.
00036675	<p>An empty shapefile was being created by a Detect Objects Using Deep Learning model when the machine intellect (.miz) file internally declared its trained cell size using cm units. If the machine intellect file was instead created from Initialize Object Detection with the CellWidth/CellHeight/CellUnits ports left empty (default values), the Detect Objects model could write a classified shapefile with expected/better results.</p> <p>Spatial Modeler has been updated so that Centimeters can be used as units in the Initialize Object Detection operator.</p>
00027263	A problem was reported when running the Classify Ground operator on a 28GB LAS pointcloud. This has been corrected so that the process does not fail.
00023294	The Indices spatial models have been updated with the new math operators (to replace deprecated versions) so they act as better examples of how to build models.
00064967	An issue has been corrected with the Kriging operator whereby it was always using the first dataset that was processed in a session even if other datasets were subsequently input. The operator is now correctly processing the input data.
00048377	Empty areas / tiles were being output when using both Classify Vegetation and Classify Buildings operators together on LiDAR point cloud data. Tiles are no longer omitted and the process runs more efficiently.

About Hexagon

Hexagon is a global leader in digital reality solutions, combining sensor, software and autonomous technologies. We are putting data to work to boost efficiency, productivity, quality and safety across industrial, manufacturing, infrastructure, public sector, and mobility applications.

Our technologies are shaping production and people-related ecosystems to become increasingly connected and autonomous — ensuring a scalable, sustainable future.

Hexagon's Safety, Infrastructure & Geospatial division improves the resilience and sustainability of the world's critical services and infrastructure. Our solutions turn complex data about people, places and assets into meaningful information and capabilities for better, faster decision-making in public safety, utilities, defense, transportation and government.

Hexagon (Nasdaq Stockholm: HEXA B) has approximately 22,000 employees in 50 countries and net sales of approximately 4.3bn EUR. Learn more at [hexagon.com](https://www.hexagon.com) and follow us [@HexagonAB](https://twitter.com/HexagonAB).

Copyright

© 2022 Hexagon AB and/or its subsidiaries and affiliates. All rights reserved

Warning: The product made the subject of this documentation, including the computer program, icons, graphical symbols, file formats, audio-visual displays and documentation (including this documentation) (collectively, the “Subject Product”) may be used only as permitted under the applicable software license agreement, and subject to all limitations and terms applicable to use of the Subject Product therein. The Subject Product contains confidential and proprietary information of Intergraph Corporation, a member of the Hexagon Group of companies (“Hexagon”), its affiliates, and/or third parties. As such, the Subject Product is protected by patent, trademark, copyright and/or trade secret law and may not be transferred, assigned, provided, or otherwise made available to any third party in violation of applicable terms and conditions cited further below.

Terms of Use

By installing, copying, downloading, accessing, viewing, or otherwise using the Subject Product, you agree to be bound by the terms of the EULA found here: https://www.hexagonsafetyinfrastructure.com/-/media/Legal/Hexagon/SI/Licenses/EULA_SA_SIG-Eng_062021.pdf.

Disclaimers

Hexagon and its suppliers believe the information in this publication is accurate as of its publication date. Hexagon is not responsible for any error that may appear in this document. The information and the software discussed in this document are subject to change without notice.

Language Translation Disclaimer: The official version of the Documentation is in English. Any translation of this document into a language other than English is not an official version and has been provided for convenience only. Some portions of a translation may have been created using machine translation. Any translation is provided “as is.” Any discrepancies or differences occurring in a translation versus the official English version are not binding and have no legal effect for compliance or enforcement purposes. Hexagon disclaims any and all warranties, whether express or implied, as to the accuracy of any translation.

Reasonable efforts have been made to provide an accurate translation; however, no translation, whether automated or provided by human translators is perfect. If any questions arise related to the accuracy of the information contained in a translated version of Documentation, please refer to its official English version. Additionally, some text, graphics, PDF documents, and/or other accompanying material may not have been translated.

Links To Third Party Websites

This Document may provide links to third party websites for your convenience and information. Third party websites will be governed by their own terms and conditions. Hexagon does not endorse companies or products to which it links.

Third party websites are owned and operated by independent parties over which Hexagon has no control. Hexagon shall not have any liability resulting from your use of the third party website. Any link you make to or from the third party website will be at your own risk and any information you share with the third party website will be subject to the terms of the third party website, including those relating to confidentiality, data privacy, and security.

Hexagon provides access to Hexagon international data and, therefore, may contain references or cross references to Hexagon products, programs and services that are not announced in your country. These references do not imply that Hexagon intends to announce such products, programs or services in your country.

Revisions

Hexagon reserves the right to revise these Terms at any time. You are responsible for regularly reviewing these Terms. Your continued use of this Document after the effective date of such changes constitutes your acceptance of and agreement to such changes.

Questions

[Contact us](#) with any questions regarding these Terms.